

Application of Tribology in Aircraft Engine Sealing Technology

Rui Liu

PHD student of Northeastern University
Marlborough Street 386, Boston, MA 02115, USA
Liu.ru@husky.neu.edu

Abstract

The seals are the important component of the aircraft engine to prevent leakage of gas or oil. Because the contact and friction problems have a great influence on the performance of the seals, the concept and theory of tribology is already widely applied in research and design processes of advanced seals. This report selected three kinds of representative seals which are commonly used on the modern aircraft engines as the research object: labyrinth seals, brush seals and mechanical face seals. The principles of every kind of seals will be analyzed from the tribology viewpoint. The concept and theory of tribology will also be applied in solving the contact and friction problems which limit the performance and the service life of seals. Thus reveals the close connection between the tribology and the aircraft engine sealing technology.

1 Introduction

Labyrinth seals, brush seals and mechanical face seals are three kinds of seals which are already commonly used in modern advanced aircraft engines. The structure of labyrinth seals is the

simplest of the three and the service life of this kind of seals is also very long. Because of these advantages, labyrinth seals are widely applied between rotor and stator of the compressor and turbine parts. Although labyrinth seals belong to non-contact seals, undesirable contacts are unavoidable under many specified conditions. Brush seals are one kind of advanced sealing technology applied in aircraft engines in recent decades. Because of the low leakage rate, the brush seals are always used in the regions of high pressure. Due to the high speed friction, the service life of brush seals and the wear problem of the rotor surface are the key problems should be solved. Mechanical face seals always applied in the bearing chambers to prevent oil leakage. It consists of two identical metal sealing rings mounted in two separate housings face-to-face on a lapped seal face. So, the Mechanical face seals could be treated as the friction problem between two faces. How to use the tribology theory to describe the fundamental principles of these seals and to analyze the contact and friction problems will be discussed in this report.

2 Labyrinth seals

2.1 Fundamental principles of Labyrinth seals

The single most common flow path seal used over turbine-engine history is the labyrinth seal (Figure 2.1). Labyrinth seals on rotating shafts provide non-contact sealing action by controlling the passage of fluid through a variety of chambers by centrifugal motion, as well as by the formation of

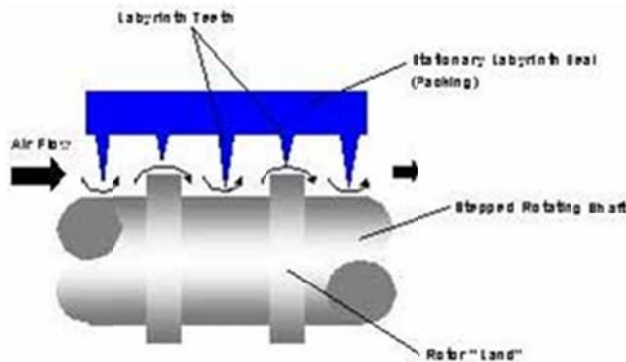

Figure 2.1: Structure of Labyrinth seals

controlled fluid vortices. At higher speeds, centrifugal motion forces the liquid towards the outside and therefore away from any passages. Similarly, if the labyrinth chambers are correctly designed, any liquid that has escaped the main chamber becomes entrapped in a labyrinth chamber, where it is forced into a vortex-like motion. This acts to prevent its escape, and also acts to repel any other fluid. The labyrinth seal

consists of multiple knife edges run in close clearance to the rotor (0.010-0.020 in.), depending on location. Labyrinth seal pressures in current engines can be as high as 400 psi depending on location. Seal temperatures are generally 1300 °F or less. Labyrinth seals are used for surface speeds up to 1500 ft/s. Labyrinth seals are clearance seals and therefore have high leakage rates. Labyrinth seals are used as shaft seals and as inner air seals - sealing the vane-to-drum inter-stage locations.

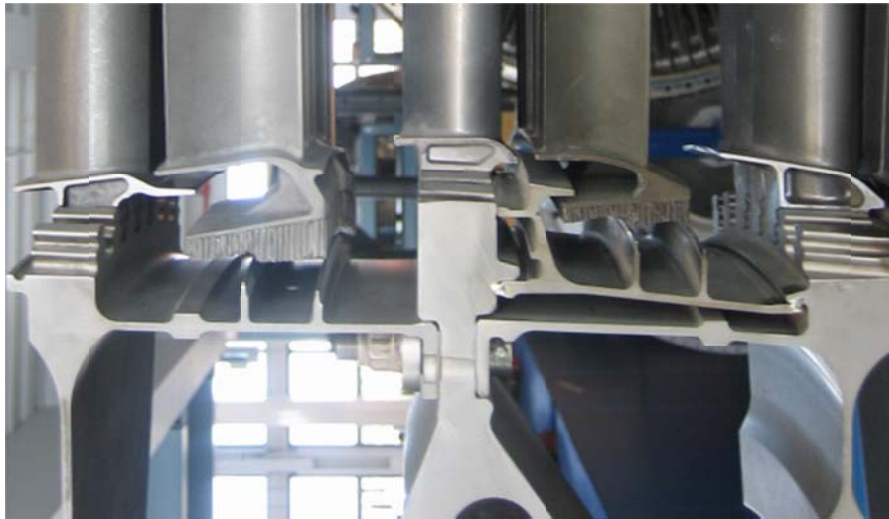

Figure 2.2: Knife edge air seals and honeycombs between vanes and drums of the low pressure turbine of PW4000 aircraft engine

2.2 The friction problem of Labyrinth seals

Actually, labyrinth seals belong to non-contact seals. When machines operate in the stable states, the rotating land will not contact with the stationary land. So the friction problem is no need to be thought of. However, because of the impacts of operational environments, working states and loading states, the contact between the rotor and the stator is hard to avoid. The contact will make the clearance of the labyrinth seals become bigger and bigger, and the friction caused by the contact will damage the substrate material. So, in order to avoid this undesirable contact or keep the clearance of the of the labyrinth seals in the event of the contact, there are various ways to solve this problem.

2.2.1 Abradable Lands

Advanced designs incorporate labyrinth knives (referred to as knife edge air seals, Figure 2.3) coated with an abrasive to maintain sharp knife edges and retain relatively good pressure drop characteristics even after a rub. Abrasive tipped seals will be run against either honeycomb or sprayed, abradable lands. Clearances will be maintained at levels as tight as is prudent. Also, the friction will limit to the abrasive and will not damage the knife edges and the substrate material of the mating land. This structure is already widely used in advanced aircraft engines.

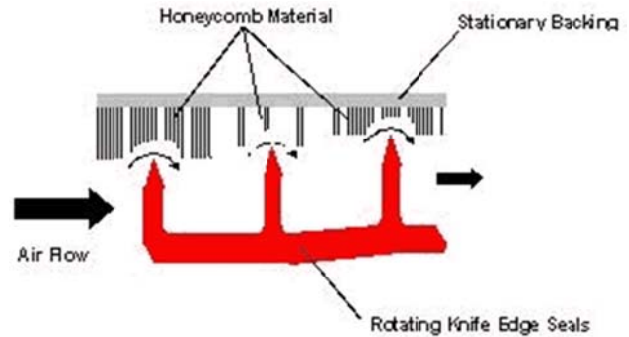

Figure 2.3: Structure of knife edge air seals

2.2.2 The Double Case and Ring Case

The high pressure compressor is the part where labyrinth knives are in wide use. Because the case of the high pressure compressor is the support structure, the bending deformation in the axial direction is hard to avoid. This deformation will change the clearance and increase the friction between the rotor and stator. Double case is the design which is used to solve this problem. The outer case is used to support the load, and the inner case is used to maintain the clearance between the rotor and stator. With this design, the clearance will not change so much although the outer case deforms a lot.

Thermal expansion is another factor which could affect the clearance between the rotor and stator. Because the material around the axial flange is always thicker than the other part, the expansion rate along the radius direction is not uniform, and the clearance will be different along the circumferential direction. In order to deal with this problem, the ring case is applied on the aircraft engine to obtain the uniform thermal expansion, because the flange is changed to the circumferential direction. Practice has shown that this design could not only solve the

friction problem caused by the thermal expansion but also increase the surge margins of the engine.

2.3 Surface Roughness Effect on the Labyrinth seals

Under stable operating states, although the knife edges and abradable land of Labyrinth seals will not contact each other, the surface roughness also affects the performance of the seals. Base on the research of Stocker et al. [1], the leakage reduction achieved with the medium rough land is believed to be the result of increased friction losses and higher surface turbulence which tends to disrupt the flow field through the seal. The benefit gained from increased friction and turbulence might be more than offset by the increased leakage area for the rough land configuration. The little change found in the single knife seal leakage for the medium rough land points out the significant contribution of the boundary layer and the seal intercavity turbulence in reducing leakage through multi-knife seals. The figure 2.2 and 2.3 show the effect of surface roughness on seal leakage.

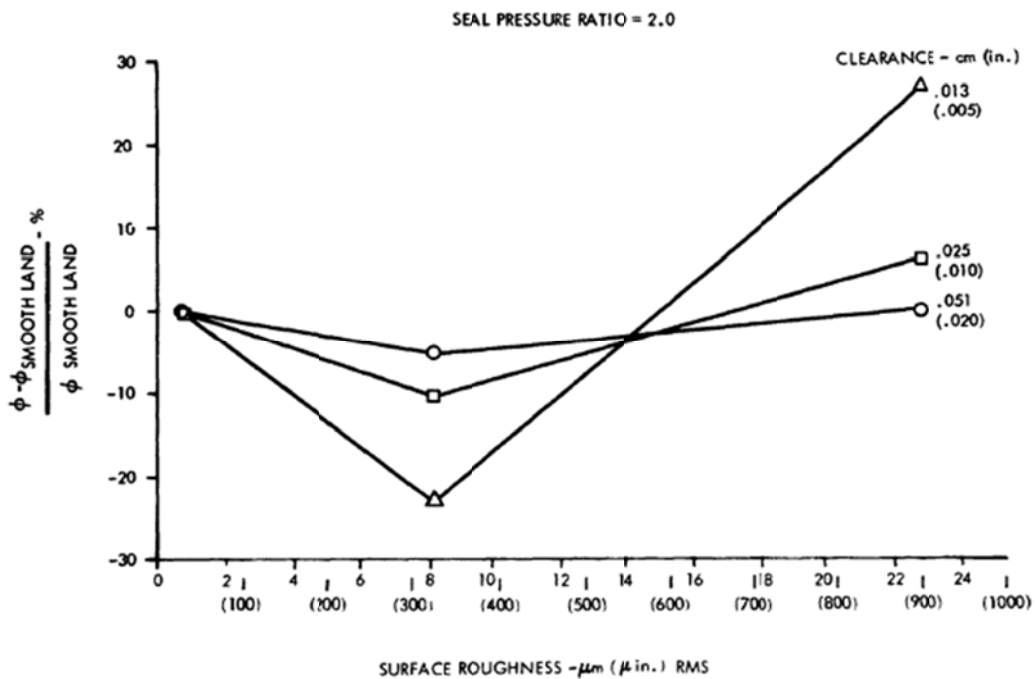

FIGURE 2.2: EFFECT OF SURFACE ROUGHNESS ON SEAL LEAKAGE COMPARED TO A SMOOTH LAND FOUR KNIFE STRAIGHT SEAL (Ref. [1])

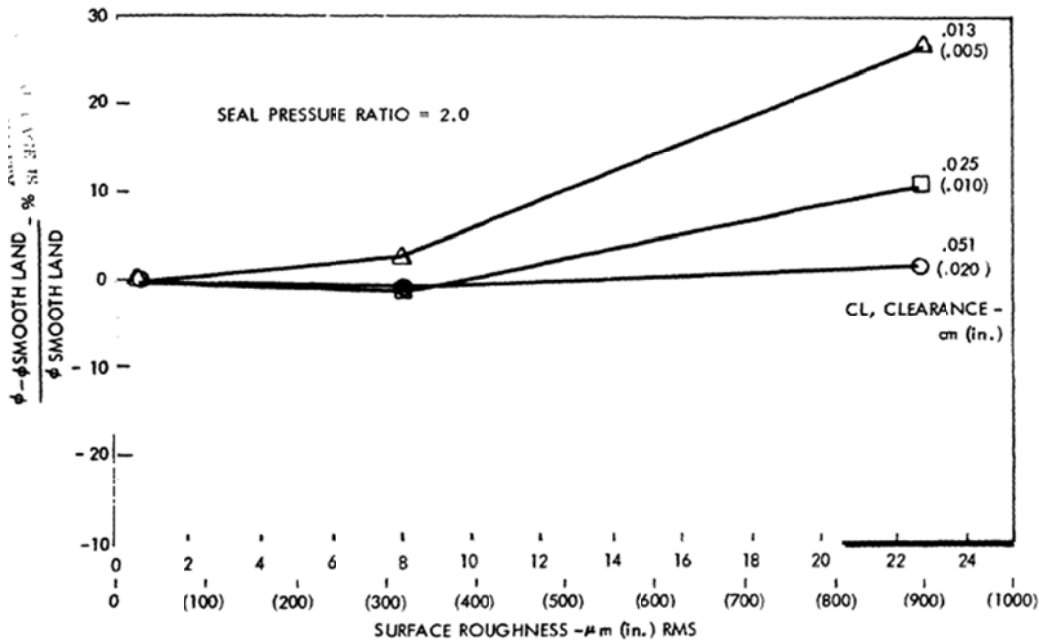

FIGURE 2.3: EFFECT OF SURFACE ROUGHNESS ON SEAL LEAKAGE COMPARED TO A SMOOTH LAND SINGLE KNIFE STRAIGHT SEAL (Ref. [1])

3 Brush seals

3.1 Fundamental principles of Brush seals

A brush seal (Figure 3.1) is an air-to-air seal that provides an alternative to labyrinth or honeycomb seals. Brush seals consist of a dense pack of bristles sandwiched between a face plate and a backing plate.

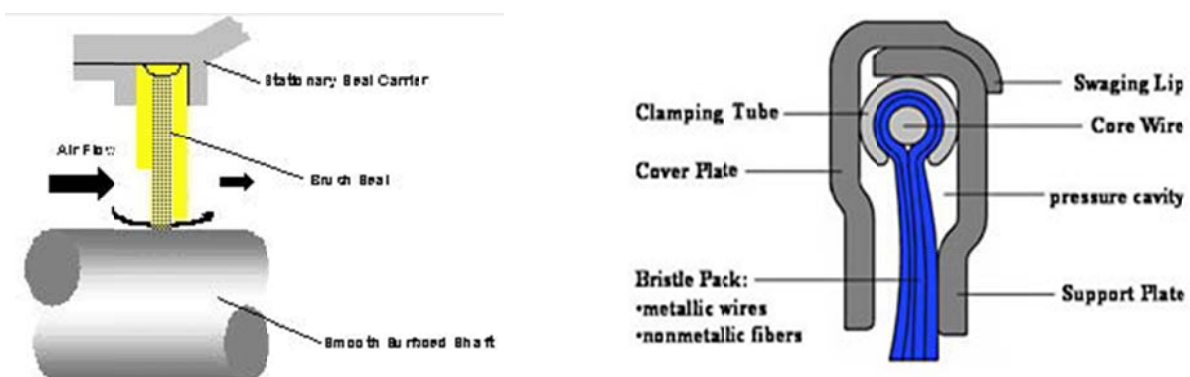

Figure 3.1: Structure of Brush Seals

The bristles are oriented to the shaft at a lay angle (generally 45 to 55 degrees) that points in the direction of rotation.

Brush seals offer many advantages when compared with traditional seals. Unlike the labyrinth seal, a brush seal is designed to come in contact with the rotor to provide a positive seal. The flexibility of the hair-like wires enables the seal to automatically adjust to accommodate rotor excursions typically encountered during start-up, shutdown or even passing through critical vibrations during normal operation. As early as the first start-up, the labyrinth seal could be compromised if it contacts the rotor. The brush seal will maintain its sealing capabilities with no significant loss in performance for up to 10,000 hours. Jet engines outfitted with brush seals can realize a 50% reduction in leakage compared to similar engines utilizing only labyrinth seals.

A primary attribute of the brush seal is its ability to accommodate transient shaft excursions and return to small running clearances, unlike labyrinth seals that wear to the full radial excursion opening large leakage paths. Brush seals are designed initially with a small radial interference £0.004 in. to accommodate seal-to-shaft centerline manufacturing variations. Leakage rates on initial run can be as little as 10-20% of comparable labyrinth seals.

Experience has shown that during engine operation, brush seal flow rates do increase due to wear. After extended operation, brush seals will wear to a clearance opening a small radial gap at part-power conditions. However, brush seal performance is generally better than the best performing labyrinth seals.

Brush seals are used in multiple stages for pressure differential above 80 psi, to prevent bristle packing and deflection under the backing plate causing excessive wear. Cobalt based alloys such as Haynes 25 are current bill-of-materials for most brush seals. Currently, seal temperatures are generally 1300 °F or less and surface speeds are generally 1000 ft/s or less. Brush seals will continue to evolve to meet the evermore demanding conditions they are subjected to. In advanced engines surface speeds are expected to reach 1650 ft/s with temperatures reaching 1500 °F. Long term durability at these extreme conditions is the primary concern. Higher temperature materials will be required for the bristles and for the wear-resistant shaft coatings. It is envisioned that cobalt based superalloy bristles may be replaced in the high temperature

(up to 1500 °F) locations. Nickel based superalloys, such as Haynes 214, form a more stable, tenacious oxide, with lower friction at higher temperatures.

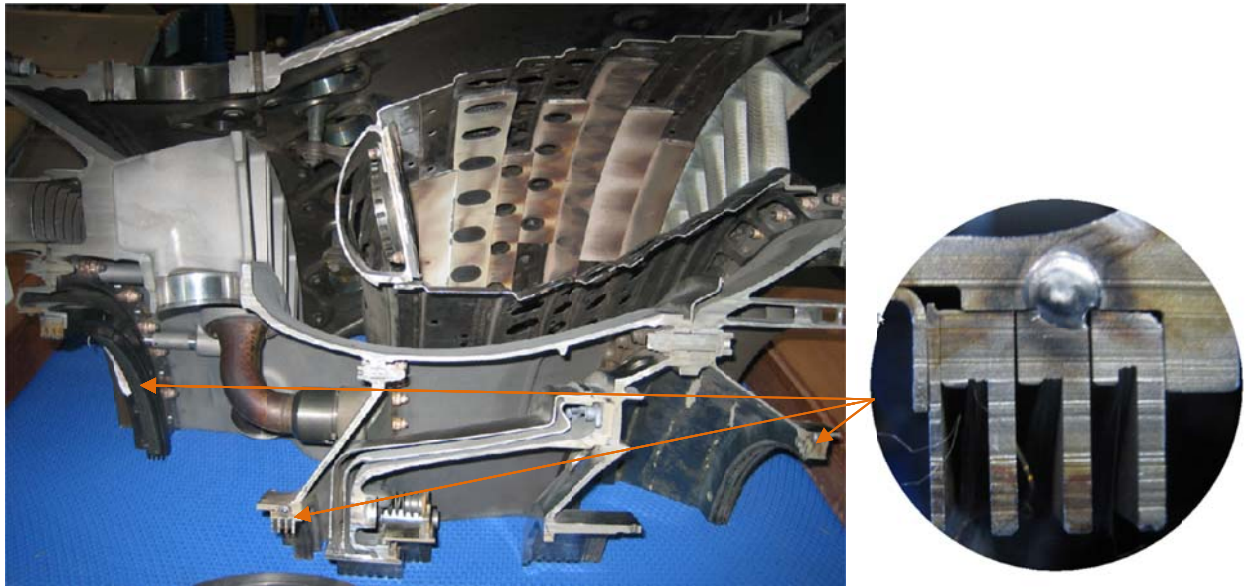

Figure 3.2: Brush seals used in the PW4000 aircraft engine

Under these extreme conditions, designs that would significantly limit the irrecoverable bristle wear are highly desirable. Researchers are investigating whether the small bristle lift forces generated during operation can aid in reducing wear. Other proprietary designs are also being investigated. Ceramic brush seals are being investigated by a number of researchers. Though not yet proven, hard ceramic bristles may be more wear resistant and may offer longer term wear lives.

3.2 Solve the friction problem of Brush Seals by finite element method

Inherent flexibility of brush seals allows fibers to compact under pressure load. Due to the frictional interaction between the fibers and the backing plate as well as within the fibers themselves, brush seals are known to exhibit pressure stiffness and hysteresis behavior. While hysteresis affects seal performance after a rotor excursion, pressure stiffening is critical in determining heat generation and seal wear during hard rubs. Typically brush-rotor contact

occurs at very high surface speeds. If not managed properly, high contact loads may result in extreme wear and damage to rotor. In order to ensure engine operational safety brush seal stiffness should be controlled through seal design and detail analysis. Finite element method is the effective method to calculate bristle forces. In the following part, I will introduce how to use finite element method to create 3-D model to obtain the tip force.

3.2.1 Finite Element Model

Based on the practical structure, create the every bristle model as a quadratic beam element. Staggered configuration is chosen as the bristle layouts, which is more common in real structures. On the other hand, the spacing of bristles is another very important factor to affect the result. The finite element model is as follow (figure 3.3):

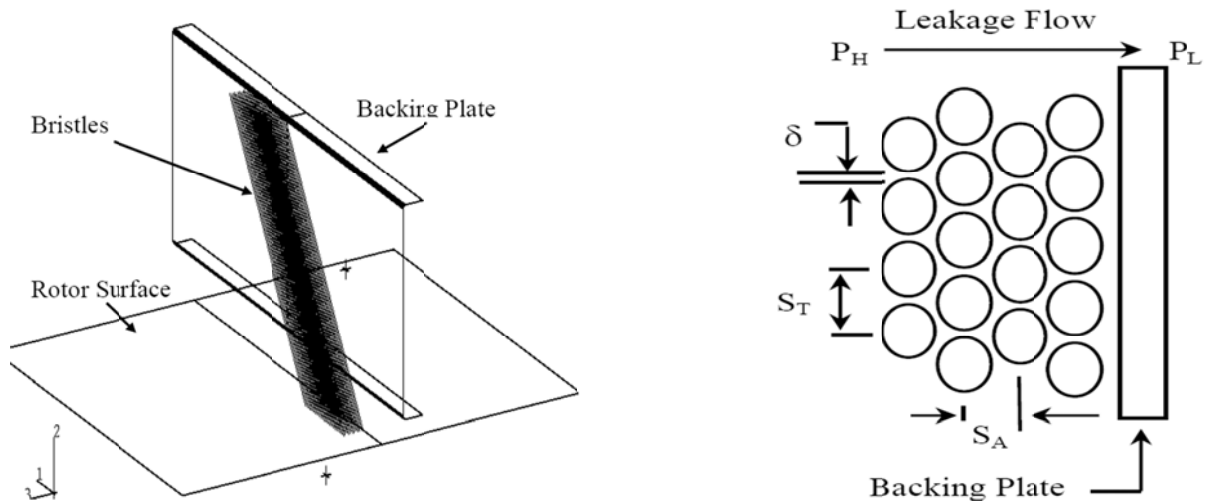

Figure 3.3: The finite element model of brush seals

3.2.2 Contact Definitions

There are three types of contact in this model. The contact between the bristles and rotor surface is defined as the rigid surface contact. The rotor surface is regarded as the rigid body, and the bristles could deform. The contact between the bristles and the backing plate is set to

the softened contact, which is defined in the ABAQUS. And the slide line contact is used to model the interaction among the bristles.

3.2.3 Friction Definitions

The friction is defined as coulomb friction for all the contacts of the seal model. The friction coefficient for Haynes 25 is 0.28 which is obtained by Crudgington et al [2].

3.2.4 Boundary Conditions

The backing plate limits the axial motion of the bristles. Because the bristles are always stuck together, we could assume the load just transfer between the first bristle and the last bristle without considering the effect of the bristles between them. And rotor surface also should have the velocity along the circumferential direction to simulate the actual operating status.

There exists an axial pressure drop with brush seals. The pressure distribution along the axial direction is already given by Bayley et al. [3] and Braun et al. [4]. And the radial pressure distribution is provided by Bayley et al. [3] and Turner et al. [5].

3.2.5 Results

Based on the simulation result, the deformation of the cross-section of the brush seals and bristle tip force under different pressure are already given by Mahmut F, Aksit [6]. The result will be shown in the picture 3.4 and 3.5. From the result, we could find out the magnitudes of the bristle tip force are decided by the pressure load. Using this method, we could simulate the operating status of the brush seal and obtain the contact pressure to predict the degree of wear.

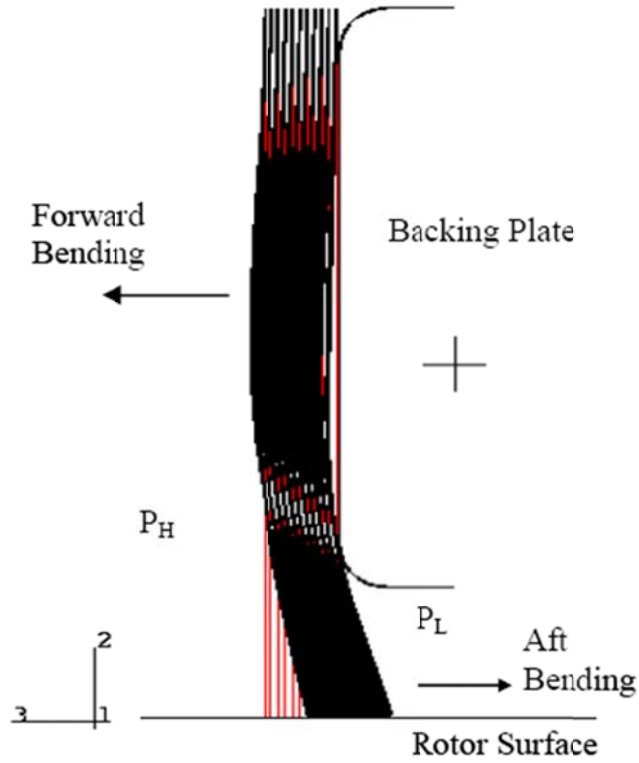

Figure 3.4: Modeled seal behavior under different pressure load (Ref. [6]).

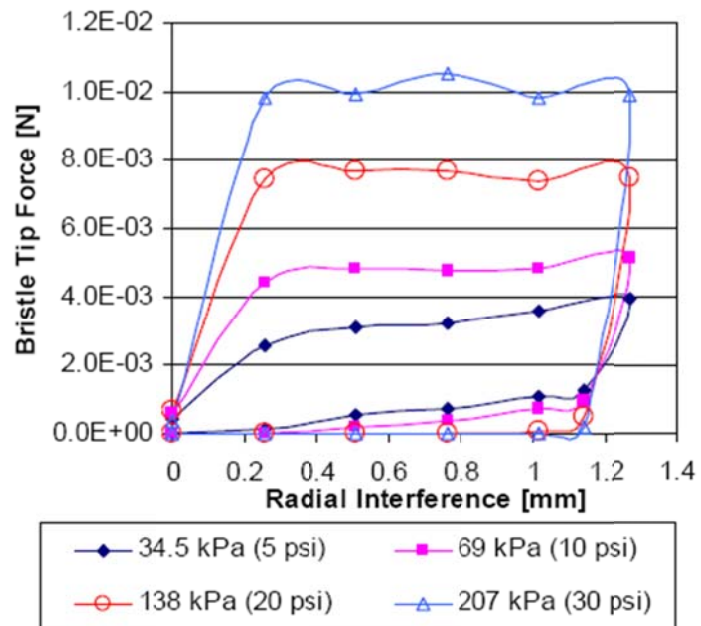

Figure 3.5: Contact force under different pressure load (Ref. [6]).

4 Mechanical Face seals

4.1 Fundamental Principles of Mechanical Face Seals

An end face mechanical seal (Figure 4.1) also referred to as a mechanical face seal but usually simply as a mechanical seal, is a type of seal utilized in rotating equipment. An end face mechanical seal uses both rigid and flexible elements that maintain contact at a sealing interface and slide on each other, allowing a rotating element to pass through a sealed case. The elements are both hydraulically and mechanically loaded with a spring or other device to maintain contact.

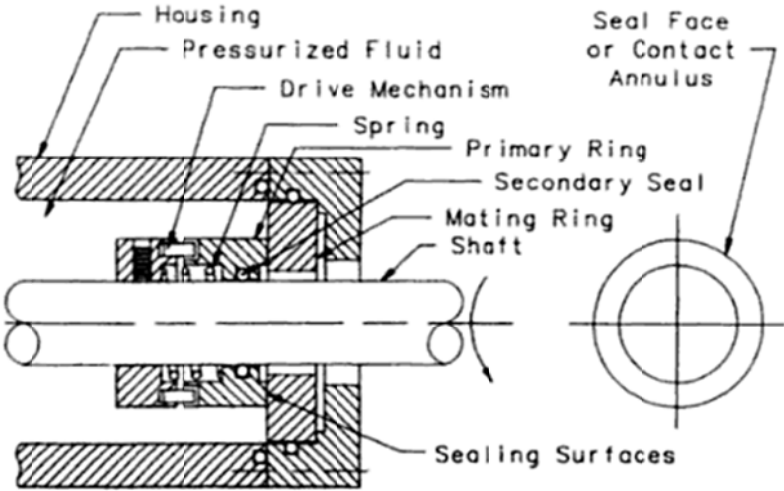

Figure 4.1: Configuration of Mechanical Face Seal (Ref. [7])

4.1.1 Balance Ratio

Balance ratio is such an important and widely used term. The definition of balance ratio shall be taken to be the ratio between the average load, p_f , expressed as a pressure and the sealed pressure, p . Figure 4.2 and Figure 4.3 show how this definition is applied to inside and outside pressurized seals. The pressure p_f is determined simply by the sealed pressure times the net area over which it acts divided by the area of the face. The balance ratio equations are

$$p\pi(r_o^2 - r_b^2) = p_f\pi(r_o^2 - r_i^2) \quad (4.1)$$

$$B = B_o = \frac{p_f}{p} = \frac{r_o^2 - r_b^2}{r_o^2 - r_i^2} \quad (\text{outside pressurized seal}) \quad (4.2)$$

$$p\pi(r_b^2 - r_o^2) = p_f\pi(r_o^2 - r_i^2) \quad (4.3)$$

$$B = B_o = \frac{p_f}{p} = \frac{r_b^2 - r_o^2}{r_o^2 - r_i^2} \quad (\text{inside pressurized seal}) \quad (4.4)$$

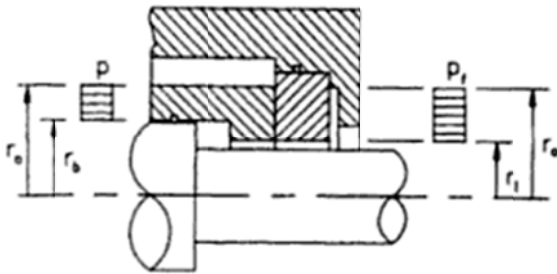

Figure 4.2: Outside pressurized seal

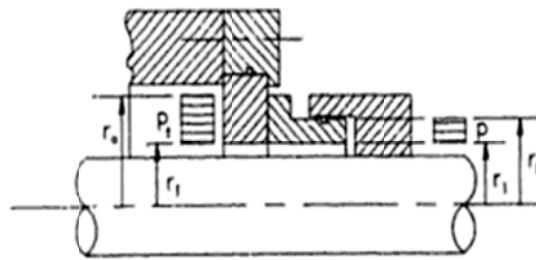

Figure 4.3: Inside pressurized seal

4.1.2 PV Parameter

PV product is the product of the nominal contact pressure on a load-bearing surface and the relative surface velocity between the load-bearing material and its counterface. It is the criterion used in the design of seals is an expression of the limit of mild adhesive wear.

4.1.3 Lubrication Regimes

Seals may operate in any one of the three lubrication regimes described in figure 4.4. In the first case, seals develop a significant film thickness such that the entire load is being supported by fluid pressure. In such cases, almost no touching occurs, friction is low, and wear will be very small.

The mixed friction is shown in the second case. This is probably the more common mode of operation for many seals at least during part of their lives. Mixed friction is characterized by the

fact that a part of the load is carried by actual mechanical contact even though most of the load may be carried by fluid pressure. The small amount of mechanical contact that does occur may be responsible for most of the total friction. Thus, in mixed friction the fraction of load supported by mechanical contact becomes very important as to the level of friction developed and consequently both friction heating and wear. The other important feature about the mixed friction regime is that the film thickness is nearly as low as it can be because even a very small decrease in nominal film thickness will radically increase the fraction of contact. Thus, leakage is about as low as it can be in this regime.

The third part illustrates the boundary friction. Boundary lubrication is characterized by the situation where either speeds are so low that fluid pressures have not developed or that the quantity of lubricant present is so small that fluid pressures cannot develop. Even in this case some small fraction of the load may be carried by fluid pressure if more than just a surface layer of lubricant is present. However, the high friction developed by the mechanical contact will cause high friction and high wear. While it is likely that boundary-type lubrication may occur in seals during some types of operation, ordinary high-speed seals simply would not survive if boundary lubrication only were operable. Friction heating and wear would be too high for most materials to survive very long.

The likely situation occurring in many seals is that both mixed lubrication and full film lubrication are occurring in different parts of the seal at the same time. Thus, some of the seal may be in the mixed lubrication regime where leakage flow is small. Other parts may be gapping open somewhat where leakage is high, but such regions may be act as a source of liquid lubricant for the mixed lubrication part of the seal.

It can be simply stated that a mechanical face seal must have an adequate state of lubrication relative to its environment and materials to operate successfully. An adequate state does not mean that the condition of lubrication must be full film. Mixed lubrication with only a small fraction of the load supported by contact will satisfy in most cases. What is absolutely essential, however, is that this satisfactory state of lubrication not deteriorates for any reason into predominantly boundary lubrication. If the satisfactory state of lubrication is lost, the seal will

wear out excessively fast or become destroyed by some thermal mechanism such as heat checking. If the state of lubrication becomes too good, such that the seal operates in the full film regime with the average film thickness being too large, then it may fail by leaking too much.

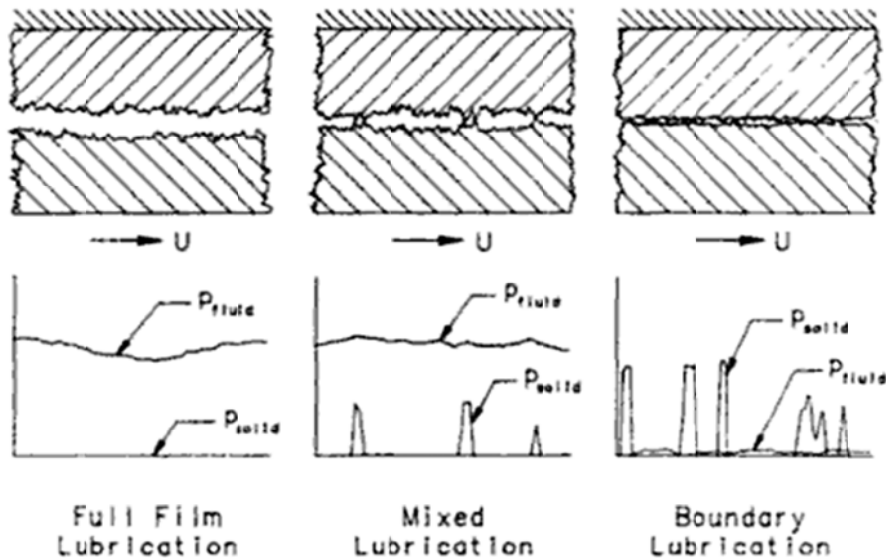

Figure 4.4: Lubrication Regimes (Ref. [7])

4.1.4 Leakage

Seal leakage is determined primarily by the average gap in the seal. The predominating parameter is the film thickness. If the film thickness over the entire seal is known, then leakage may be calculated. If a seal has low leakage, most likely it is operating predominately in the mixed lubrication regime. In this regime the effective value of the fluid film thickness is of the order of magnitude of the combined mean-to-peak roughness heights and leakage may be estimated using this value. If a seal leaks excessively, then it is likely that at least in some regions the seal gap may be several times the average peak roughness height. Leakage is controlled by the gap in the seal, which in turn is controlled by lubrication.

4.2 Sealing Surface Definition and Measurement

4.2.1 Surface Profiles

Figure 4.5 shows surface profiles obtained for actual seal materials. It shows the effect of wear on the lapped carbon. The profile shows how the asperity tips have been worn off. In fact the carbon surface is now more properly characterized as consisting of flat-topped regions of near equal height surrounded by depressions and valleys. There are many different features and types of information that can be obtained from such profiles. These include height distributions, roughness measures, characteristic length measures and autocorrelation, asperity tip radii, and load bearing curves.

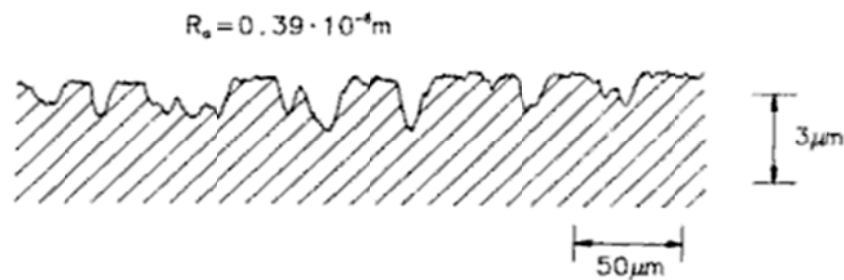

Figure 4.5: Surface Profile of a Worn Carbon Surface (Ref. [7]).

4.2.2 Distribution of Surface Heights

Height of a surface is usually considered to be a random variable. Figure 4.6 shows how this conception can be applied. Rather than picking random locations to measure height, one may take a surface profile of sufficient length and then make a histogram of the heights of equally spaced points taken from the profile as shown in Figure 4.6. The resulting curve is considered to be a probability density function of surface height. This function is referred to as the all-ordinate density function to distinguish it from density functions of peak heights or valley heights.

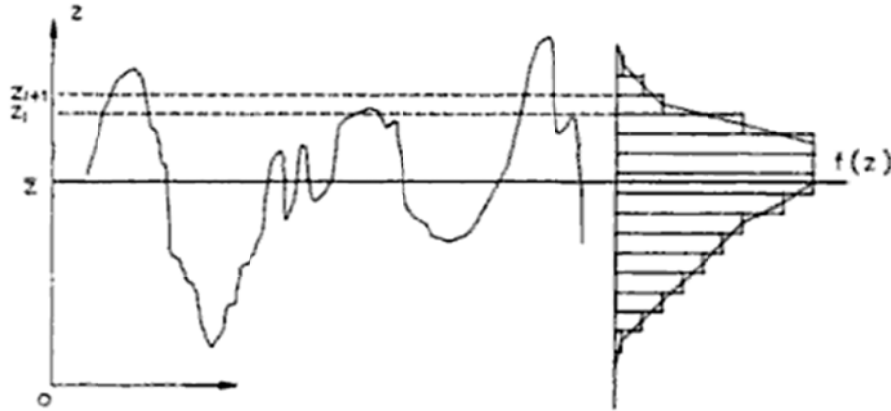

Figure 4.6: A surface profile and its all-ordinate density function (Ref. [7])

There are two very important measures that can be derived either from having a sample of surface heights or from the density function itself. These two parameters are already described on the class. First, the mean value is given by

$$\bar{z} = \frac{1}{N} \sum_{i=1}^N z_i \quad (\text{discrete height style}) \quad (4.5)$$

$$\bar{z} = \frac{1}{L} \int_{x=0}^{x=L} z dx \quad (\text{continuous height style}) \quad (4.6)$$

The second parameter is the standard deviation

$$\sigma^2 = \frac{1}{N} \sum_{i=1}^N (z_i - \bar{z})^2 \quad (\text{discrete height style}) \quad (4.7)$$

$$\sigma^2 = \frac{1}{L} \int_{x=0}^{x=L} (z - \bar{z})^2 dx \quad (\text{continuous height style}) \quad (4.8)$$

4.2.3 Surface Roughness

There are many roughness parameters in use. Arithmetical mean roughness (Ra) is by far the most common

$$Ra = \frac{1}{N} \sum_{i=1}^N |z_i - \bar{z}| \quad (\text{discrete height style}) \quad (4.9)$$

$$Ra = \frac{1}{L} \int_{x=0}^{x=L} |z - \bar{z}| dx \text{ (continuous height style)} \quad (4.10)$$

Root Mean Square or RMS Roughness is another averaging measurement

$$R_q^2 = \frac{1}{N} \sum_{i=1}^N z_i^2 \text{ (discrete height style)} \quad (4.11)$$

$$R_q^2 = \frac{1}{L} \int_{x=0}^{x=L} z_i^2 dx \text{ (continuous height style)} \quad (4.12)$$

4.2.4 Normal Distribution

The “normal distribution” is given by a particular density function, the Gaussian curve, which has certain important mathematical features. It happens that data from many natural physical phenomena fit the normal distribution curve. Many other mathematical curves can also be used to fit such data equally well, but the normal distribution function is used because of its early origins and because it provides certain mathematical conveniences. One should always recognize that the normal distribution is the approximation of a physical phenomenon and provides no deeper meaning. In fact the use of such an idealization may be quite misleading. For example, the normal distribution, when fitted to a density function for a surface, predicts the existence asperities of infinite height and valleys of infinite depth, clearly not physically true.

Density function shapes for real surfaces do vary considerably. In fact this variation from the Gaussian curve is very useful in characterizing the surface. Yet, for many analyzes and discussions, surfaces are considered to be “normal”. There are several reasons. The first is that many surfaces can be well approximated by the normal distribution function. Second, it is often more important to be able to use a mathematically convenient function for analysis and discussion than it is to avoid the errors that might be introduced by making such an assumption. Third, even though the entire surface may not be normal, it is likely that the interactive part of the surface, which is the region at and just below the peaks, does behave as a normal function. Finally, since most engineers are familiar with the normal distribution but not other distributions, use of the normal distribution approximation simply makes discussing surfaces in

terms of their statistical properties easier to understand. Thus, this distribution is always selected to be an approximation to the distribution of surface heights for seal surfaces.

4.3 Tribological Properties

While many of the physical and mechanical properties do affect tribological behavior, there are nevertheless some material-specific tribological properties that one does not find included as material properties. Three such properties of importance are friction coefficient, wear rate, and the PV (pressure times velocity) limit. While some might debate that these are properties because the values depend strongly on nonmaterial factors that are difficult to control or undefined, there is nevertheless a strong relationship between the properties mentioned and material type. Data for these properties is very useful.

Friction coefficient in seals is specific to the system consisting of the two face materials, their precise geometry, the fluid, the speed, the pressure, and so forth. In fact, it is well known that by designing different experiments for seals, one can measure a wide range of friction coefficients. Thus, reported values of friction coefficients are specific to the exact conditions under which the measurements were taken and have limited value in another context.

The second type of tribological data of interest is wear rate. This data may not repeat from seal design to seal design because the condition of lubrication may be totally different. To use the wear coefficient data, the wear coefficient K is defined as is described by Johnson and Schoenherr (1980):

$$\frac{K}{H} = \frac{\text{Face wear rate}}{\text{Net contact pressure} \times \text{speed}} = \frac{\frac{\Delta h}{\Delta t}}{p_m \times U} \quad (4.13)$$

where the hardness H must be defined in the same units as pressure. Thus, for hardness values expressed by a Brinell number or by the Vicker's hardness number, which are both in (kg/mm^2) . The wear coefficient K is consistent with adhesive wear theory (See Halling, 1978). Ideally, if

one knows the hardness H , the wear coefficient is used as K/H such that one obtains a wear coefficient for a given material pair of given hardness.

The pressure times velocity limit, which is commonly known as the PV limit, can be considered as a material property even though just like friction coefficient, it can be influenced by many other factors of design. PV limit does have a very strong material dependence. The question that arises in relation to the PV limit is what limit one is talking about. In some seal tests PV is given its limiting value based on limiting wear rate to satisfactory levels.

4.4 Fluid Pressure Distribution

In order to analyze the friction of the mechanical seals, the fluid pressure distribution is also need to be considered. It is more convenient to use the Reynolds equation in its polar coordinate form. With reference to the polar coordinate system shown in Figure 4.7, we could obtain

$$q_{\theta} = -\frac{h^3}{12\mu} \frac{\partial p}{r \partial \theta} + r\omega \frac{h}{2} \quad (4.14)$$

$$q_r = -\frac{h^3}{12\mu} \frac{\partial p}{\partial r} \quad (4.15)$$

With reference to Figure 4.7 the net sum of the volume rate of flow into the control volume can be obtained by summing the flows shown. Thus, neglecting the squeeze film effects as before, continuity requires that

$$\frac{\partial q_{\theta}}{\partial \theta} + \frac{\partial}{\partial r}(r q_r) = 0 \quad (4.16)$$

Upon substitution of equations 4.14 and 4.15 into equation 4.16, the Reynolds equation in polar coordinates is given by

$$\frac{1}{r} \frac{\partial}{\partial \theta} \left(\frac{h^3}{12\mu} \frac{\partial p}{\partial \theta} \right) + \frac{\partial}{\partial r} \left(\frac{r h^3}{12\mu} \frac{\partial p}{\partial r} \right) = \frac{r\omega}{2} \frac{\partial h}{\partial \theta} \quad (4.17)$$

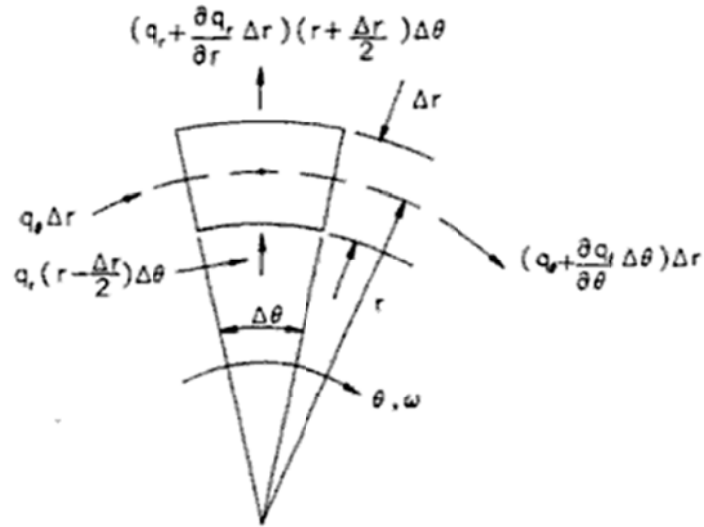

Figure 4.7: Control volume in polar coordinates

4.5 Numerical Methods of Solution

In order to obtain the solution of friction problem of mechanical seals, the Finite-Difference method is the useful method which could be considered. Nowadays Finite Element Method is already become a powerful mathematical tools to simulate the engineering problems with the support of computer software. This method is also widely applied in solving the friction problems of mechanical face seals. Veronica Argesanu and Lucian Madaras [8] used Finite Element Method to solve the leakage, wear and friction problems of the mechanical face seals. Carmen Sticlaru, Arjana Davidescu [9] also applied Finite Element Method to analyze one type of face seals.

5 Conclusion

From the above description and analysis, it is obvious that the three kinds of seals which are widely applied in modern aircraft engines have the close relation with the tribology theory, although there are great differences among the principles and the structures of three kinds of seals. Labyrinth seals are a kind of non-contact seals. During the stable operating status, the surface roughness also has the impact on the performance of the seals. When the working status of Labyrinth seals becomes stable, several powerful methods are used to deal with friction problems causing by the undesirable contact. For brush seals, contact forces between the tip of bristles and rotor surface is the very important factor to affect the performance and the friction ratio of the brush seals. The friction problems of the interface also need to be solved with the help of the tribology theory. The mechanical face seals could be treated as the friction problem between two faces, and a lot of existing tribology models and theories could be applied to solve this problem. From these cases, we could find out the importance of the tribology theory during the design process of seals. With the development of the research and the improvement of the calculate method, more detailed and more deep problem will be considered, and it will have an important meaning to promoting the efficiency and extending the service life of the modern aircraft engine.

Bibliography

- [1] H. L. Stocker, D. M. Cox, G. F. Holle. Aerodynamic Performance of Conventional and Advanced Design Labyrinth Seals with Solid-smooth, Abradable, and Honeycomb Lands. National Aeronautics and Space Administration, NAS 2-20056, 1977.
- [2] Crugington, P. F, and Bowsher, A, Brush Seal Pack Hysteresis, 2002, AIAA Paper No. AIAA-2002-3794.
- [3] Bayley, F.J., and Long, C.A., A Combined Experimental and Theoretical Study of Flow and Pressure Distributions in a Brush Seal, ASME J. Eng. Gas Turbines Power, 115, No.2 (1993) 404-410.
- [4] Braun, M. J., Hendricks, R. C., and Canacci, V., Flow Visualization in a Simulated Brush Seals, ASME Paper No. 90-GT-217, 1990.
- [5] Turner M. T., Chew, J. W., and Long, C.A., Experimental Investigation and Mathematical Modeling of Clearance Brush Seals, ASME J. Eng. Gas Turbines Power, 120, No.3, 1998, 573-579.
- [6] Mahmut F. Aksit*. 3-D Analysis of High Density Brush Stiffness with Friction-Pressure Coupling, Sabanci University, Istanbul, Turkey, 34956.
- [7] Alan O. Lebeck, Principles and Design of Mechanical Face Seals, 1991 by John Wiley & Sons, Inc.
- [8] Veronica Argesanu, Lucian Madaras, Leakage, Wear and Friction in the Mechanical Face Seals Analyzed by FEM, The Annals of University, FASCICLE VIII, Tribology, 2003 ISSN 1221-4590.
- [9] Carmen Sticlaru, Arjana Davidescu, Studies by Finite Element Method Applied on Face Seal, Mechanical Engineering Vol. 2, N^o 1, 2004, pp. 59-68.